



Grayhill, Inc.

## 62S11-L0-040C

Dio brojeva:

62S11-L0-040C

Proizvođač / robna marka:

Grayhill, Inc.

Opis proizvoda

ROTARY ENCODER OPTICAL 32PPR

Liste podataka:

 62S11-L0-040C.pdf

Status RoHS

 Bez olova / RoHS sukladni

Brod od

Hong Kong

Put pošiljke

DHL/Fedex/TNT/UPS/EMS

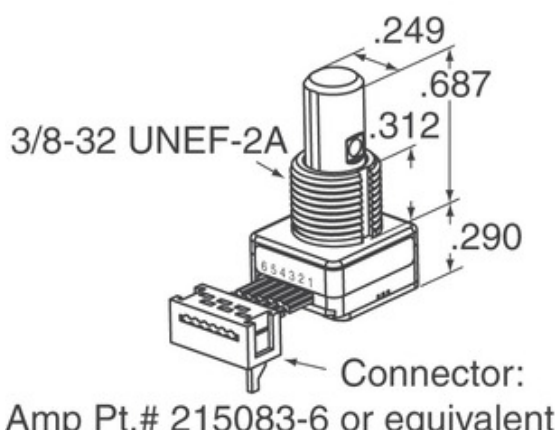
[ZAHTJEV ZA PONUDU](#)

Slika može biti reprezentativna. Pogledajte specifikacije za pojedinosti o proizvodu.



### Specifikacije 62S11-L0-040C

DIO BROJEVA	62S11-L0-040C
PROIZVOĐAČ	Grayhill, Inc.
OPIS	ROTARY ENCODER OPTICAL 32PPR
STATUS SLOBODNOG OLOVA / ROHS-A	Bez olova / RoHS sukladni
OBRAZAC PODATAKA	 62S11-L0-040C.pdf
NAPAJANJE	5V
STIL ZAVRŠETKA	Cable with Connector
NIZ	62S
ROTACIJSKI ŽIVOT (CIKLUSI MIN)	1M
PULSE PO REVOLUCIJI	32
VRSTA IZLAZA	Quadrature (Incremental)
DRUGA IMENA	62S11L0040C
ORIJENTACIJA	Vertical
VRSTA MONTAŽE	Panel Mount
RAZINA OSJETLJIVOSTI VLAGE (MSL)	1 (Unlimited)
PROIZVOĐAČ STANDARDNO VRIJEME DOVRŠETKA	8 Weeks
STATUS SLOBODNOG OLOVA / ROHS-A	Lead free / RoHS Compliant
VRSTA DAVAČA	Optical
ZAPONSKA	Yes
UGRAĐENI PREKIDAČ	No
VRSTA POGONA	1/4" Dia Flatted End

### Povezane oznake

Grayhill, Inc. 62S11-L0-040C	Distributer 62S11-L0-040C	Dobavljač 62S11-L0-040C
Cijena 62S11-L0-040C	Slike 62S11-L0-040C	62S11-L0-040C slika
62S11-L0-040C PDF tablični list	62S11-L0-040C Preuzimanje tablice podataka	62S11-L0-040C list s podacima
Stock 62S11-L0-040C	Kupite 62S11-L0-040C	Kupite Grayhill, Inc. 62S11-L0-040C
Grayhill, Inc. 62S11-L0-040C	Dobavljač Grayhill, Inc.	Distributer Grayhill, Inc.
Grayhill, Inc. 62S11-L0-040C	Grayhill Inc. 62S11-L0-040C	

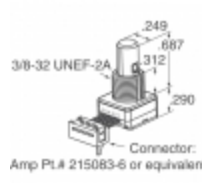
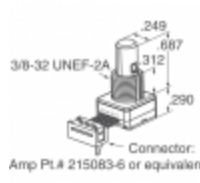
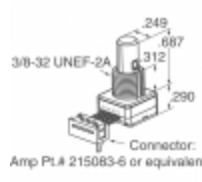
### Povezani proizvodi

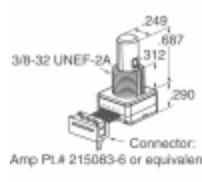
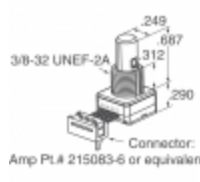
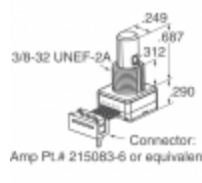
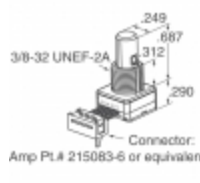
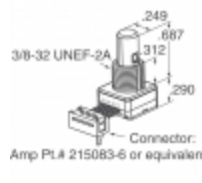
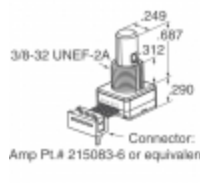
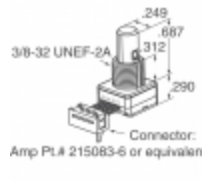
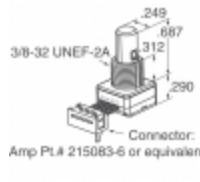
 <p><b>62S11-L0-P</b> Proizvođači: Grayhill, Inc. Opis: ROTARY ENCODER OPTICAL 32PPR Na lageru: Out stock</p> <p><a href="#">RFQ</a></p>	 <p><b>62S11-H9-060SH</b> Proizvođači: Grayhill, Inc. Opis: ROTARY ENCODER OPTICAL 32PPR Na lageru: Out stock</p> <p><a href="#">RFQ</a></p>
 <p><b>62S11-L0-055C</b> Proizvođači: Grayhill, Inc. Opis: ROTARY ENCODER OPTICAL 32PPR Na lageru: Out stock</p> <p><a href="#">RFQ</a></p>	 <p><b>62S11-L0-040S</b> Proizvođači: Grayhill, Inc. Opis: ROTARY ENCODER OPT 32PPR 4" CBL Na lageru: Out stock</p> <p><a href="#">RFQ</a></p>
 <p><b>62S11-H9-060C</b> Proizvođači: Grayhill, Inc. Opis: ROTARY ENCODER OPTICAL 32PPR Na lageru: Out stock</p> <p><a href="#">RFQ</a></p>	 <p><b>62S11-L0-060CH</b> Proizvođači: Grayhill, Inc. Opis: ROTARY ENCODER OPTICAL 32PPR Na lageru: Out stock</p> <p><a href="#">RFQ</a></p>
 <p><b>62S11-L0-060S</b> Proizvođači: Grayhill, Inc. Opis: ROTARY ENCODER OPTICAL 32PPR Na lageru: Out stock</p> <p><a href="#">RFQ</a></p>	 <p><b>62S11-L0-020CH</b> Proizvođači: Grayhill, Inc. Opis: ROTARY ENCODER OPTICAL 32PPR Na lageru: Out stock</p> <p><a href="#">RFQ</a></p>
 <p><b>62S11-L0-060SH</b> Proizvođači: Grayhill, Inc. Opis: ROTARY ENCODER OPTICAL 32PPR Na lageru: Out stock</p> <p><a href="#">RFQ</a></p>	 <p><b>62S11-H9-PH</b> Proizvođači: Grayhill, Inc. Opis: ROTARY ENCODER OPTICAL 32PPR Na lageru: Out stock</p> <p><a href="#">RFQ</a></p>
 <p><b>62S11-L0-020C</b> Proizvođači: Grayhill, Inc. Opis: ROTARY ENCODER OPTICAL 32PPR Na lageru: Out stock</p> <p><a href="#">RFQ</a></p>	 <p><b>62S11-H9-P</b> Proizvođači: Grayhill, Inc. Opis: ROTARY ENCODER OPTICAL 32PPR Na lageru: Out stock</p> <p><a href="#">RFQ</a></p>