



Grayhill, Inc.

62S11-H9-PH

Dio brojeva:

62S11-H9-PH

Proizvođač / robna marka:

Grayhill, Inc.

Opis proizvoda

ROTARY ENCODER OPTICAL 32PPR

Liste podataka:

 62S11-H9-PH.pdf

Status RoHS

 Bez olova / RoHS sukladni

Brod od

Hong Kong

Put pošiljke

DHL/Fedex/TNT/UPS/EMS

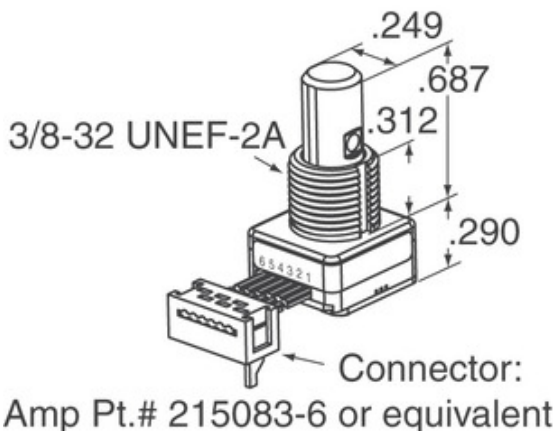
[ZAHTJEV ZA PONUDU](#)

Slika može biti reprezentativna. Pogledajte specifikacije za pojedinosti o proizvodu.



Specifikacije 62S11-H9-PH

DIO BROJEVA	62S11-H9-PH
PROIZVOĐAČ	Grayhill, Inc.
OPIS	ROTARY ENCODER OPTICAL 32PPR
STATUS SLOBODNOG OLOVA / ROHS-A	Bez olova / RoHS sukladni
OBRAZAC PODATAKA	 62S11-H9-PH.pdf
NAPAJANJE	5V
STIL ZAVRŠETKA	PC Pin
NIZ	62S
ROTACIJSKI ŽIVOT (CIKLUSI MIN)	1M
PULSE PO REVOLUCIJI	32
VRSTA IZLAZA	Quadrature (Incremental)
DRUGA IMENA	62S11H9PH
ORIJENTACIJA	Vertical
VRSTA MONTAŽE	PCB, Through Hole
RAZINA OSJETLJIVOSTI VLAŽE (MSL)	1 (Unlimited)
PROIZVOĐAČ STANDARDNO VRIJEME DOVRŠETKA	8 Weeks
STATUS SLOBODNOG OLOVA / ROHS-A	Lead free / RoHS Compliant
VRSTA DAVAČA	Optical
ZAPONSKA	Yes
UGRAĐENI PREKIDAČ	Yes
VRSTA POGONA	1/4" Dia Flatted End

Povezane oznake

Grayhill, Inc. 62S11-H9-PH	Distributer 62S11-H9-PH	Dobavljač 62S11-H9-PH
Cijena 62S11-H9-PH	Slike 62S11-H9-PH	62S11-H9-PH slika
62S11-H9-PH PDF tablični list	62S11-H9-PH Preuzimanje tablice podataka	62S11-H9-PH list s podacima
Stock 62S11-H9-PH	Kupite 62S11-H9-PH	Kupite Grayhill, Inc. 62S11-H9-PH
Grayhill, Inc. 62S11-H9-PH	Dobavljač Grayhill, Inc.	Distributer Grayhill, Inc.
Grayhill, Inc. 62S11-H9-PH	Grayhill Inc. 62S11-H9-PH	

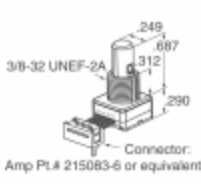
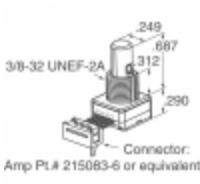
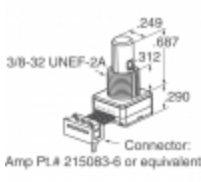
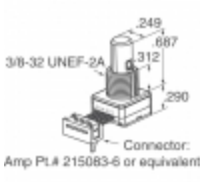
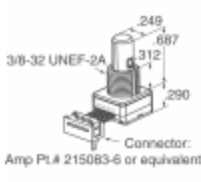
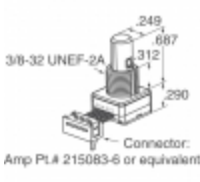
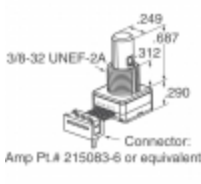
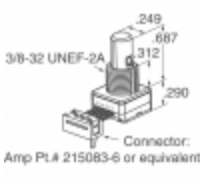
Povezani proizvodi

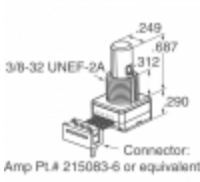
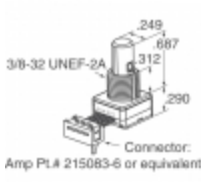
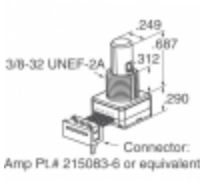
 <p>62S11-L0-020C Proizvođači: Grayhill, Inc. Opis: ROTARY ENCODER OPTICAL 32PPR Na lageru: Out stock</p> <p>RFQ</p>	 <p>62S11-H9-050S Proizvođači: Grayhill, Inc. Opis: ROTARY ENCODER OPTICAL 32PPR Na lageru: Out stock</p> <p>RFQ</p>
 <p>62S11-L0-020CH Proizvođači: Grayhill, Inc. Opis: ROTARY ENCODER OPTICAL 32PPR Na lageru: Out stock</p> <p>RFQ</p>	 <p>62S11-L0-060CH Proizvođači: Grayhill, Inc. Opis: ROTARY ENCODER OPTICAL 32PPR Na lageru: Out stock</p> <p>RFQ</p>
 <p>62S11-H9-040C Proizvođači: Grayhill, Inc. Opis: ROTARY ENCODER OPTICAL 32PPR Na lageru: Out stock</p> <p>RFQ</p>	 <p>62S11-H9-P Proizvođači: Grayhill, Inc. Opis: ROTARY ENCODER OPTICAL 32PPR Na lageru: Out stock</p> <p>RFQ</p>
 <p>62S11-L0-055C Proizvođači: Grayhill, Inc. Opis: ROTARY ENCODER OPTICAL 32PPR Na lageru: Out stock</p> <p>RFQ</p>	 <p>62S11-H9-060SH Proizvođači: Grayhill, Inc. Opis: ROTARY ENCODER OPTICAL 32PPR Na lageru: Out stock</p> <p>RFQ</p>
 <p>62S11-L0-040S Proizvođači: Grayhill, Inc. Opis: ROTARY ENCODER OPT 32PPR 4" CBL Na lageru: Out stock</p> <p>RFQ</p>	 <p>62S11-H9-040S Proizvođači: Grayhill, Inc. Opis: ROTARY ENCODER OPTICAL 32PPR Na lageru: Out stock</p> <p>RFQ</p>
 <p>62S11-H9-060C Proizvođači: Grayhill, Inc. Opis: ROTARY ENCODER OPTICAL 32PPR Na lageru: Out stock</p> <p>RFQ</p>	 <p>62S11-L0-040C Proizvođači: Grayhill, Inc. Opis: ROTARY ENCODER OPTICAL 32PPR Na lageru: Out stock</p> <p>RFQ</p>