



Grayhill, Inc.

62S11-L0-020C

Dio brojeva:

62S11-L0-020C

Proizvođač / robna marka:

Grayhill, Inc.

Opis proizvoda

ROTARY ENCODER OPTICAL 32PPR

Liste podataka:

 62S11-L0-020C.pdf

Status RoHS

 Bez olova / RoHS sukladni

Brod od

Hong Kong

Put pošiljke

DHL/Fedex/TNT/UPS/EMS

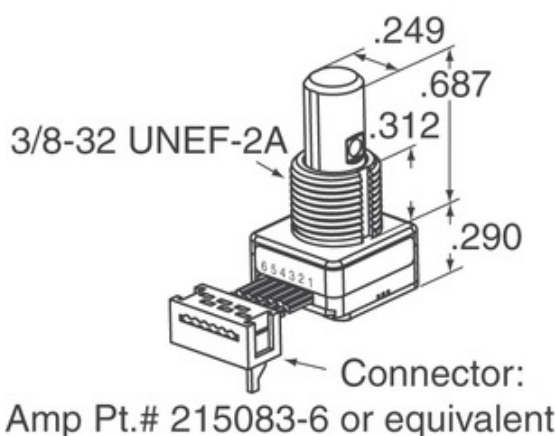

Slika može biti reprezentativna. Pogledajte specifikacije za pojedinosti o proizvodu.

[ZAHTJEV ZA PONUDU](#)



Specifikacije 62S11-L0-020C

DIO BROJEVA	62S11-L0-020C
PROIZVOĐAČ	Grayhill, Inc.
OPIS	ROTARY ENCODER OPTICAL 32PPR
STATUS SLOBODNOG OLOVA / ROHS-A	Bez olova / RoHS sukladni
OBRAZAC PODATAKA	 62S11-L0-020C.pdf
NAPAJANJE	5V
STIL ZAVRŠETKA	Cable with Connector
NIZ	62S
ROTACIJSKI ŽIVOT (CIKLUSI MIN)	1M
PULSE PO REVOLUCIJI	32
VRSTA IZLAZA	Quadrature (Incremental)
DRUGA IMENA	62S11L0020C
ORIJENTACIJA	Vertical
VRSTA MONTAŽE	Panel Mount
RAZINA OSJETLJIVOSTI VLAGE (MSL)	1 (Unlimited)
PROIZVOĐAČ STANDARDNO VRIJEME DOVRŠETKA	8 Weeks
STATUS SLOBODNOG OLOVA / ROHS-A	Lead free / RoHS Compliant
VRSTA DAVAČA	Optical
ZAPONSKA	Yes
UGRAĐENI PREKIDAČ	No
VRSTA POGONA	1/4" Dia Flatted End

Povezane oznake

Grayhill, Inc. 62S11-L0-020C	Distributer 62S11-L0-020C	Dobavljač 62S11-L0-020C
Cijena 62S11-L0-020C	Slike 62S11-L0-020C	62S11-L0-020C slika
62S11-L0-020C PDF tablični list	62S11-L0-020C Preuzimanje tablice podataka	62S11-L0-020C list s podacima
Stock 62S11-L0-020C	Kupite 62S11-L0-020C	Kupite Grayhill, Inc. 62S11-L0-020C
Grayhill, Inc. 62S11-L0-020C	Dobavljač Grayhill, Inc.	Distributer Grayhill, Inc.
Grayhill, Inc. 62S11-L0-020C	Grayhill Inc. 62S11-L0-020C	

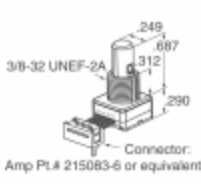
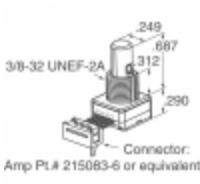
Povezani proizvodi

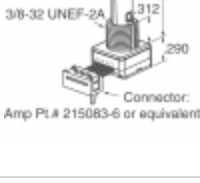
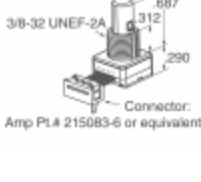
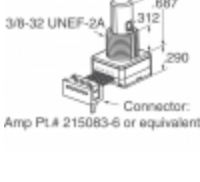
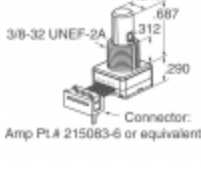
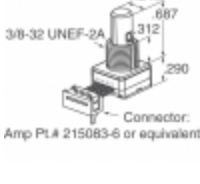
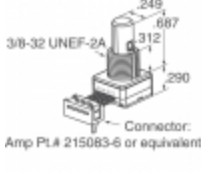
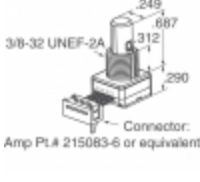
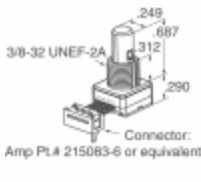
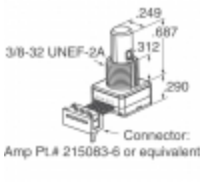
 <p>62S11-H9-060SH Proizvođači: Grayhill, Inc. Opis: ROTARY ENCODER OPTICAL 32PPR Na lageru: Out stock</p> <p>RFQ</p>	 <p>62S11-L0-060CH Proizvođači: Grayhill, Inc. Opis: ROTARY ENCODER OPTICAL 32PPR Na lageru: Out stock</p> <p>RFQ</p>
 <p>62S11-L0-040S Proizvođači: Grayhill, Inc. Opis: ROTARY ENCODER OPT 32PPR 4" CBL Na lageru: Out stock</p> <p>RFQ</p>	 <p>62S11-H9-060C Proizvođači: Grayhill, Inc. Opis: ROTARY ENCODER OPTICAL 32PPR Na lageru: Out stock</p> <p>RFQ</p>
 <p>62S11-L0-060S Proizvođači: Grayhill, Inc. Opis: ROTARY ENCODER OPTICAL 32PPR Na lageru: Out stock</p> <p>RFQ</p>	 <p>62S11-L0-020CH Proizvođači: Grayhill, Inc. Opis: ROTARY ENCODER OPTICAL 32PPR Na lageru: Out stock</p> <p>RFQ</p>
 <p>62S11-L0-040C Proizvođači: Grayhill, Inc. Opis: ROTARY ENCODER OPTICAL 32PPR Na lageru: Out stock</p> <p>RFQ</p>	 <p>62S11-H9-PH Proizvođači: Grayhill, Inc. Opis: ROTARY ENCODER OPTICAL 32PPR Na lageru: Out stock</p> <p>RFQ</p>
 <p>62S11-H9-050S Proizvođači: Grayhill, Inc. Opis: ROTARY ENCODER OPTICAL 32PPR Na lageru: Out stock</p> <p>RFQ</p>	 <p>62S11-H9-040S Proizvođači: Grayhill, Inc. Opis: ROTARY ENCODER OPTICAL 32PPR Na lageru: Out stock</p> <p>RFQ</p>
 <p>62S11-H9-P Proizvođači: Grayhill, Inc. Opis: ROTARY ENCODER OPTICAL 32PPR Na lageru: Out stock</p> <p>RFQ</p>	 <p>62S11-L0-055C Proizvođači: Grayhill, Inc. Opis: ROTARY ENCODER OPTICAL 32PPR Na lageru: Out stock</p> <p>RFQ</p>