



Grayhill, Inc.

62S11-H9-050S

Dio brojeva:

62S11-H9-050S

Proizvođač / robna marka:

Grayhill, Inc.

Opis proizvoda

ROTARY ENCODER OPTICAL 32PPR

Liste podataka:

 62S11-H9-050S.pdf

Status RoHS

 Bez olova / RoHS sukladni

Brod od

Hong Kong

Put pošiljke

DHL/Fedex/TNT/UPS/EMS

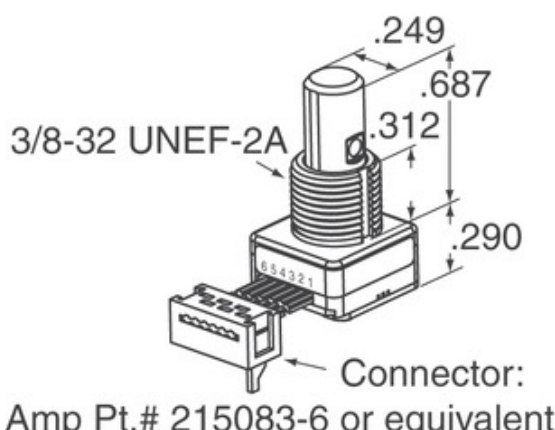

Slika može biti reprezentativna. Pogledajte specifikacije za pojedinosti o proizvodu.

[ZAHTJEV ZA PONUDU](#)

Specifikacije 62S11-H9-050S

| | |
|---|---|
| DIO BROJEVA | 62S11-H9-050S |
| PROIZVOĐAČ | Grayhill, Inc. |
| OPIS | ROTARY ENCODER OPTICAL 32PPR |
| STATUS SLOBODNOG OLOVA / ROHS-A | Bez olova / RoHS sukladni |
| OBRAZAC PODATAKA |  62S11-H9-050S.pdf |
| NAPAJANJE | 5V |
| STIL ZAVRŠETKA | Cable Leads |
| NIZ | 62S |
| ROTACIJSKI ŽIVOT (CIKLUSI MIN) | 1M |
| PULSE PO REVOLUCIJI | 32 |
| VRSTA IZLAZA | Quadrature (Incremental) |
| DRUGA IMENA | 62S11H9050S |
| ORIJENTACIJA | Vertical |
| VRSTA MONTAŽE | Panel Mount |
| RAZINA OSJETLJIVOSTI VLAGE (MSL) | 1 (Unlimited) |
| PROIZVOĐAČ STANDARDNO VRIJEME DOVRŠETKA | 8 Weeks |
| STATUS SLOBODNOG OLOVA / ROHS-A | Lead free / RoHS Compliant |
| VRSTA DAVAČA | Optical |
| ZAPONSKA | Yes |
| UGRAĐENI PREKIDAČ | Yes |
| VRSTA POGONA | 1/4" Dia Flatted End |

Povezane oznake

| | | |
|---------------------------------|--|-------------------------------------|
| Grayhill, Inc. 62S11-H9-050S | Distributer 62S11-H9-050S | Dobavljač 62S11-H9-050S |
| Cijena 62S11-H9-050S | Slike 62S11-H9-050S | 62S11-H9-050S slika |
| 62S11-H9-050S PDF tablični list | 62S11-H9-050S Preuzimanje tablice podataka | 62S11-H9-050S list s podacima |
| Stock 62S11-H9-050S | Kupite 62S11-H9-050S | Kupite Grayhill, Inc. 62S11-H9-050S |
| Grayhill, Inc. 62S11-H9-050S | Dobavljač Grayhill, Inc. | Distributer Grayhill, Inc. |
| Grayhill, Inc. 62S11-H9-050S | Grayhill Inc. 62S11-H9-050S | |

Povezani proizvodi

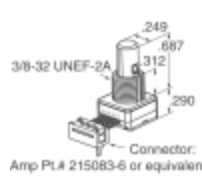
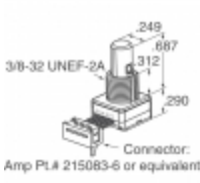
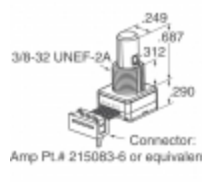
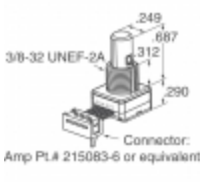
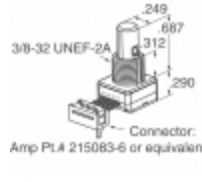
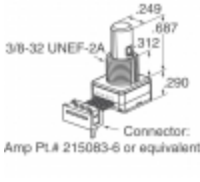
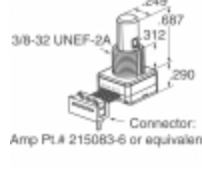
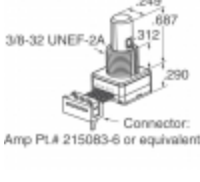
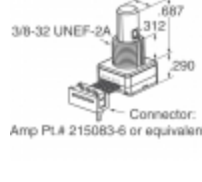
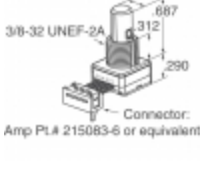
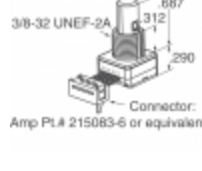
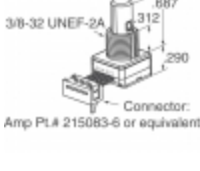
| | |
|--|---|
|  <p>62S11-H9-040C Proizvođači: Grayhill, Inc. Opis: ROTARY ENCODER OPTICAL 32PPR Na lageru: Out stock</p> <p>RFQ</p> |  <p>62S11-H9-040S Proizvođači: Grayhill, Inc. Opis: ROTARY ENCODER OPTICAL 32PPR Na lageru: Out stock</p> <p>RFQ</p> |
|  <p>62S11-L0-020C Proizvođači: Grayhill, Inc. Opis: ROTARY ENCODER OPTICAL 32PPR Na lageru: Out stock</p> <p>RFQ</p> |  <p>62S11-H9-020C Proizvođači: Grayhill, Inc. Opis: ROTARY ENCODER OPTICAL 32PPR Na lageru: Out stock</p> <p>RFQ</p> |
|  <p>62S11-H9-PH Proizvođači: Grayhill, Inc. Opis: ROTARY ENCODER OPTICAL 32PPR Na lageru: Out stock</p> <p>RFQ</p> |  <p>62S11-L0-020CH Proizvođači: Grayhill, Inc. Opis: ROTARY ENCODER OPTICAL 32PPR Na lageru: Out stock</p> <p>RFQ</p> |
|  <p>62S11-H9-P Proizvođači: Grayhill, Inc. Opis: ROTARY ENCODER OPTICAL 32PPR Na lageru: Out stock</p> <p>RFQ</p> |  <p>62S11-H0-PH Proizvođači: Grayhill, Inc. Opis: ROTARY ENCODER OPTICAL 32PPR Na lageru: Out stock</p> <p>RFQ</p> |
|  <p>62S11-H9-060C Proizvođači: Grayhill, Inc. Opis: ROTARY ENCODER OPTICAL 32PPR Na lageru: Out stock</p> <p>RFQ</p> |  <p>62S11-H9-020S Proizvođači: Grayhill, Inc. Opis: ROTARY ENCODER OPTICAL 32PPR Na lageru: Out stock</p> <p>RFQ</p> |
|  <p>62S11-H9-060SH Proizvođači: Grayhill, Inc. Opis: ROTARY ENCODER OPTICAL 32PPR Na lageru: Out stock</p> <p>RFQ</p> |  <p>62S11-H9-025S Proizvođači: Grayhill, Inc. Opis: ROTARY ENCODER OPTICAL 32PPR Na lageru: Out stock</p> <p>RFQ</p> |