

**Panasonic**

Panasonic

## JQ1-18V-F

Dio brojeva:

Proizvođač / robna marka:

Opis proizvoda

Liste podataka:

Status RoHS

Brod od

Put pošiljke

JQ1-18V-F

Panasonic

JQ RELAY 1 FORM C 18V

 JQ1-18V-F.pdf

 Bez olova / RoHS sukladni

Hong Kong

DHL/Fedex/TNT/UPS/EMS

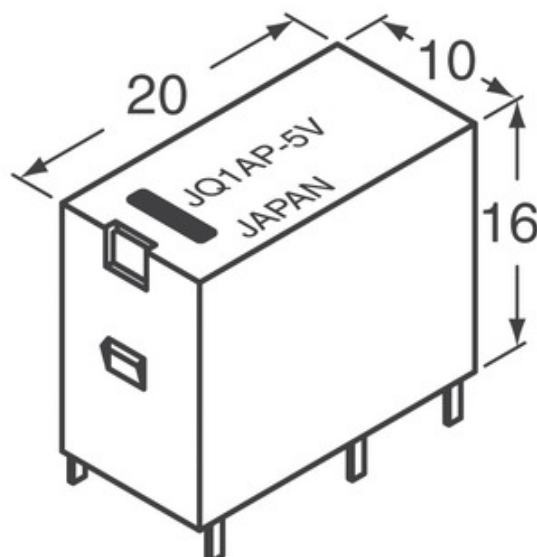

Slika može biti reprezentativna. Pogledajte specifikacije za pojedinosti o proizvodu.

**ZAHTJEV ZA PONUDU**













### Specifikacije JQ1-18V-F

DIO BROJEVA	JQ1-18V-F
PROIZVOĐAČ	Panasonic
OPIS	JQ RELAY 1 FORM C 18V
STATUS SLOBODNOG OLOVA / ROHS-A	Bez olova / RoHS sukladni
OBRAZAC PODATAKA	 JQ1-18V-F.pdf
NIZ	*
RAZINA OSJETLJIVOSTI VLAGE (MSL)	1 (Unlimited)
PROIZVOĐAČ STANDARDNO VRIJEME DOVRŠETKA	12 Weeks
STATUS SLOBODNOG OLOVA / ROHS-A	Lead free / RoHS Compliant
DETALJAN OPIS	Relay Coil

### Povezane oznake

Panasonic JQ1-18V-F	Distributer JQ1-18V-F	Dobavljač JQ1-18V-F
Cijena JQ1-18V-F	Slike JQ1-18V-F	JQ1-18V-F slika
JQ1-18V-F PDF tablični list	JQ1-18V-F Preuzimanje tablice podataka	JQ1-18V-F list s podacima
Stock JQ1-18V-F	Kupite JQ1-18V-F	Kupite Panasonic JQ1-18V-F
Panasonic JQ1-18V-F	Dobavljač Panasonic	Distributer Panasonic
Panasonic JQ1-18V-F	Panasonic - Consumer Division JQ1-18V-F	Panasonic - Consumer Electronics Corp. JQ1-18V-F
Panasonic Battery Group JQ1-18V-F	Panasonic Electric Works - ACSD JQ1-18V-F	Panasonic Electronic Components - Semiconductor Pr JQ1-18V-F
Panasonic - ATG JQ1-18V-F	Panasonic - BSG JQ1-18V-F	Panasonic - DTG JQ1-18V-F
Panasonic Electric Works JQ1-18V-F	Panasonic Electronic Components JQ1-18V-F	Panasonic Industrial Automation Sales JQ1-18V-F
Panasonic Semiconductor JQ1-18V-F		

### Povezani proizvodi

 <p><b>JQ1-6V-F</b> Proizvođači: Panasonic Opis: RELAY GENERAL PURPOSE SPDT 5A 6V Na lageru: Out stock <a href="#">RFQ</a></p>	 <p><b>JQ1-5V</b> Proizvođači: Panasonic Opis: RELAY GENERAL PURPOSE SPDT 5A 5V Na lageru: Out stock <a href="#">RFQ</a></p>
 <p><b>JQ1-3V</b> Proizvođači: Panasonic Opis: RELAY GENERAL PURPOSE SPDT 5A 3V Na lageru: Out stock <a href="#">RFQ</a></p>	 <p><b>JQ1-24V</b> Proizvođači: Panasonic Opis: RELAY GEN PURPOSE SPDT 5A 24V Na lageru: Out stock <a href="#">RFQ</a></p>
 <p><b>JQ1-5V-F</b> Proizvođači: Panasonic Opis: RELAY GENERAL PURPOSE SPDT 5A 5V Na lageru: Out stock <a href="#">RFQ</a></p>	 <p><b>JQ1-48V</b> Proizvođači: Panasonic Opis: RELAY GEN PURPOSE SPDT 5A 48V Na lageru: Out stock <a href="#">RFQ</a></p>
 <p><b>JQ1-48V-F</b> Proizvođači: Panasonic Opis: RELAY GEN PURPOSE SPDT 5A 48V Na lageru: 100 pcs <a href="#">RFQ</a></p>	 <p><b>JQ1-6V</b> Proizvođači: Panasonic Opis: RELAY GENERAL PURPOSE SPDT 5A 6V Na lageru: Out stock <a href="#">RFQ</a></p>
 <p><b>JQ1-12V</b> Proizvođači: Panasonic Opis: RELAY GEN PURPOSE SPDT 5A 12V Na lageru: Out stock <a href="#">RFQ</a></p>	 <p><b>JQ1-18V</b> Proizvođači: Panasonic Opis: RELAY GEN PURPOSE SPDT 5A 18V Na lageru: Out stock <a href="#">RFQ</a></p>
 <p><b>JQ1-24V-F</b> Proizvođači: Panasonic Opis: RELAY GEN PURPOSE SPDT 5A 24V Na lageru: Out stock <a href="#">RFQ</a></p>	 <p><b>JQ1-12V-F</b> Proizvođači: Panasonic Opis: RELAY GEN PURPOSE SPDT 5A 12V Na lageru: Out stock <a href="#">RFQ</a></p>